

NOTE: We recommend that this product is installed by the professional only. We accept no liability for damages caused by incorrect assembly, installation or use. If there is any doubt, please contact the specialist from the seller for help.







IMPORTANT!

- For safety reasons, the wall or mounting surface must be capable of supporting the combined weight of the mount and the display; otherwise the structure must be reinforced.
- Safety gear and proper tools must be used. A minimum of two people are required for this installation. Failure to do so can result in property damage and/or serious injury.
- Make sure that no electrical cables, water pipes or gas pipes are located within the wall.

Tools required for the installation:

- Phillips Head Screw Driver
- Electric or Portable Drill
- 1/4" (6 mm) Drill Bit + Stud Finder (Drywall Installation)
- 7/16" (11 mm) Masonry Bit (Concrete Installation)

Also make sure that all of the hardware has been included with your mount. You should find the following:

- | | | | | | | | | |
|--------------------|-----|---|---------------------|-----|---|----------------|-----|---|
| (A) M6x50 Lag Bolt | X 4 |  | (B) Concrete Anchor | X 4 |  | (C) M6 Washer | X 8 |  |
| (D) M4x14 Bolt | X 4 |  | (E) M6x14 Bolt | X 4 |  | (F) M8x16 Bolt | X 4 |  |

Installing the Wall Mount

Drywall Installation

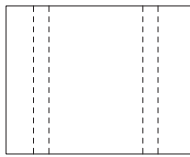

Center of the stud

1

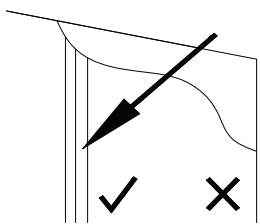

Stud Finder



Tape Measure

2

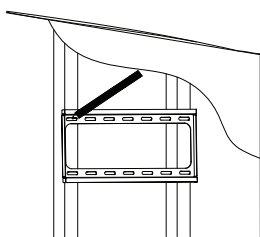

Make sure it is level.
Use a pen to mark four or six locations.



Concrete/Brick Installation

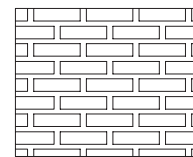

1

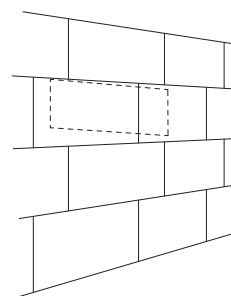

Tape Measure



2

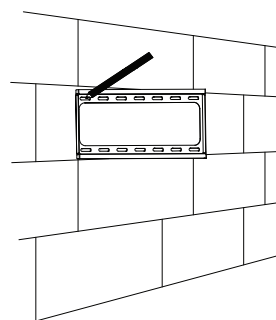

Make sure it is level.
Use a pen to mark four or six locations.



3

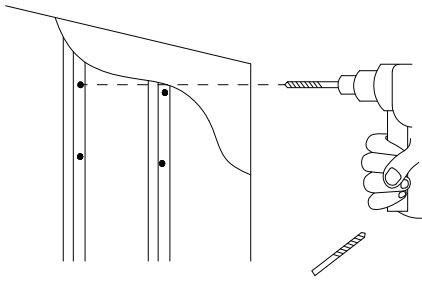

3

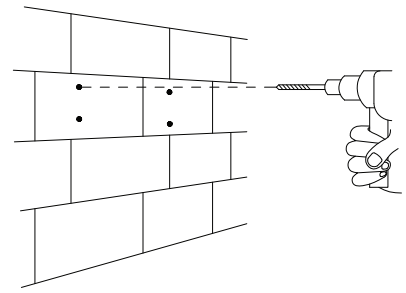

Insert one Concrete Anchor (B) into each hole.

4

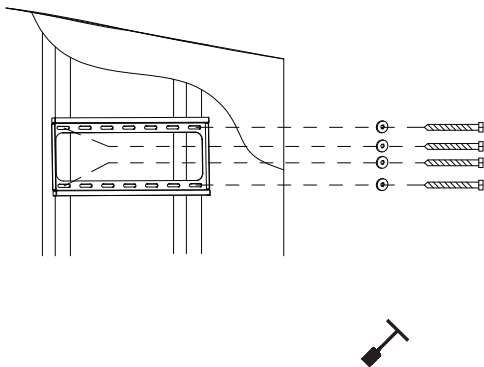

Fix the wall plate to the wall using the Lag Bolt (A) provided.

4

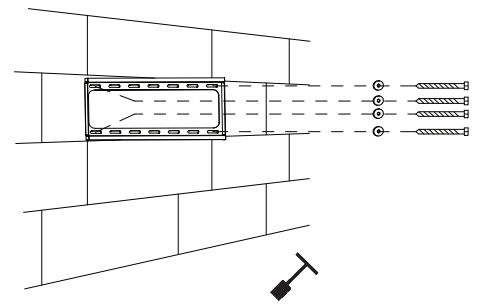

Fix the wall plate to the wall using the Lag Bolt (A) provided.

5

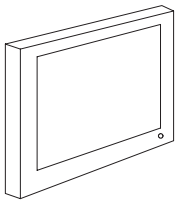

Choose proper bolt from D,E,F according to TV vesa holes.

6

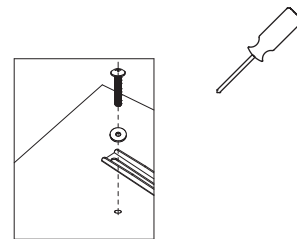

Fix bracket to tv with screw and washer
Do not use the M6 Washers (F) if you are using the M8 Bolts .

6

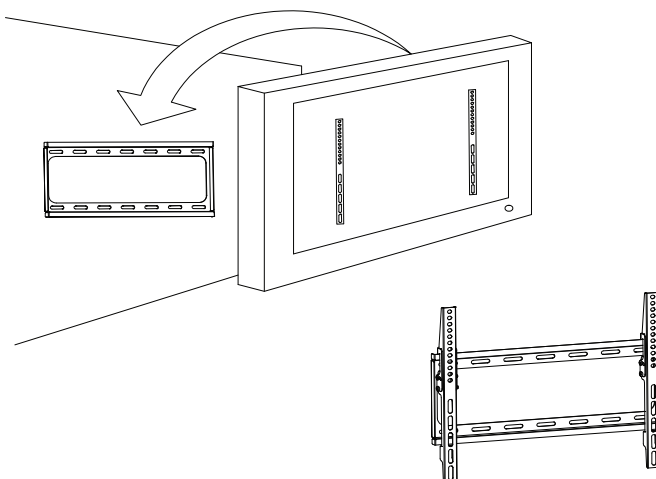

For additional security, Tighten the screws.

7

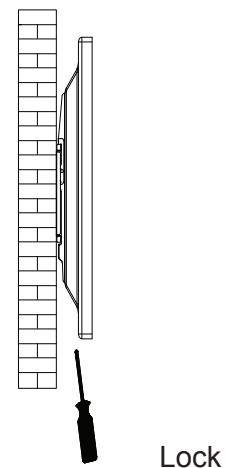

Tighten or loosen the screw to make the tilt happen.